

**HUGO SUSPENSION / HUGO VERTICAL**

**Light Source:** 20W - 100~240 Vac/24 Vdc - 3.500 Lumen - 3.000 Kelvin - CRI >90, Integrated LED



**Dimmable:** PWM, 0-10

**Materials:** Lentiflex®

**Weight:** net 2,98 lbs - gross 4,85 lbs

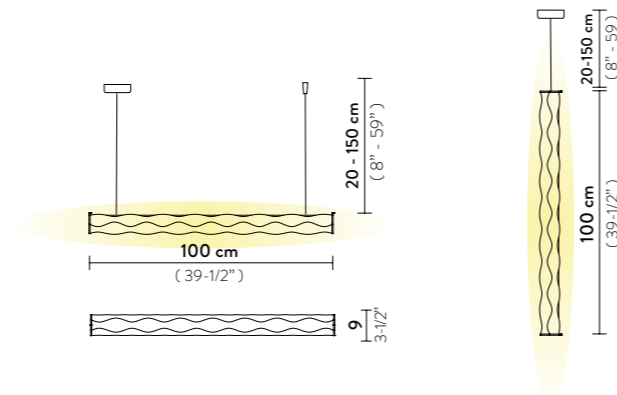
**Packaging:** 44,88 x 6,3 x h. 6,3 in



FINISH	PRODUCT CODE	CANOPY DETAILS	
 <p>PRISMA</p>	<b>HUGS000PRS01THR000US</b>	 <p>Ø 5,51 x h. 1,77 in</p>	
	<b>HUGS000PRS01TVT000US</b> VERTICAL		
	ACCESSORIES MUST BE ORDERED WITH THE PRODUCTS		
	6M CABLE KIT		
	6M CABLE KIT VERTICAL		
	<b>DALI ACC00DALOUNI000B0</b>		
<b>TRIAC ACC00TRI0110000H0</b>			
<b>CASAMBI ACC00CAI0220000A0</b>			

**HUGO FLOOR**

**Light Source:** 40W - 100~240 Vac/24 Vdc - 7.000 Lumen - 3.000 Kelvin - CRI >90, Integrated LED

**Dimmable:** with integrated dimmer

**Materials:** Lentiflex®

**With:** Soft touch dimming system



**Weight:** net 13,67 lbs - gross 18,74 lbs

**Packaging:** 44,88 x 6,3 x h. 6,3 in

44,88 x 6,3 x h. 6,3 in

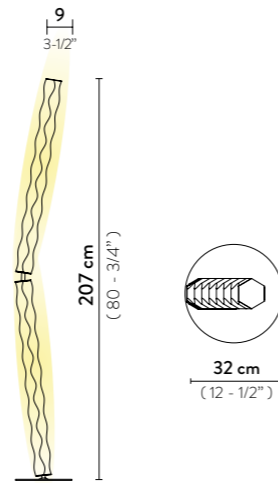
18,5 x 18,5 x h. 2,76 in



FINISH	PRODUCT CODE	DETAILS
 <p>PRISMA</p>	<b>HUGFM00PRS00000000US</b>	<p>Soft Touch dimming</p> 

**HUGO ARCHITECTURAL 2**

**Light Source:** 40W - 100~240 Vac/24 Vdc - 7.000 Lumen - 3.000 Kelvin - CRI >90, Integrated LED

**Dimmable:** PWM, 0-10

**Materials:** Lentiflex®

**Weight:** net 7,72 lbs - gross 11,02 lbs

**Packaging:** 44,88 x 6,3 x h. 6,3 in

44,88 x 6,3 x h. 6,3 in

16,93 x 10,24 x h. 2,76 in

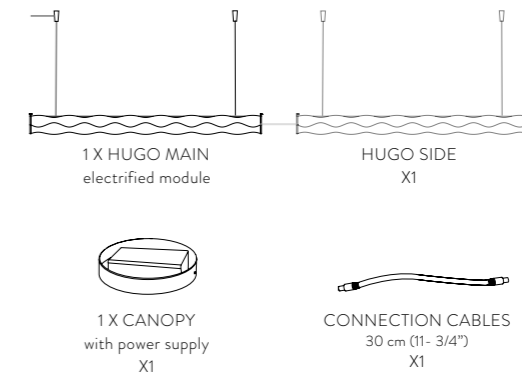

**HUGO ARCHITECTURAL 3**

**Light Source:** 60W - 100~130 Vac/24 Vdc - 10.500 Lumen - 3.000 Kelvin - CRI >90, Integrated LED

**Dimmable:** Triac Trailing Edge

**Materials:** Lentiflex®

**Weight:** net 10,7 lbs - gross 15,43 lbs

**Packaging:** 44,88 x 6,3 x h. 6,3 in

44,88 x 6,3 x h. 6,3 in

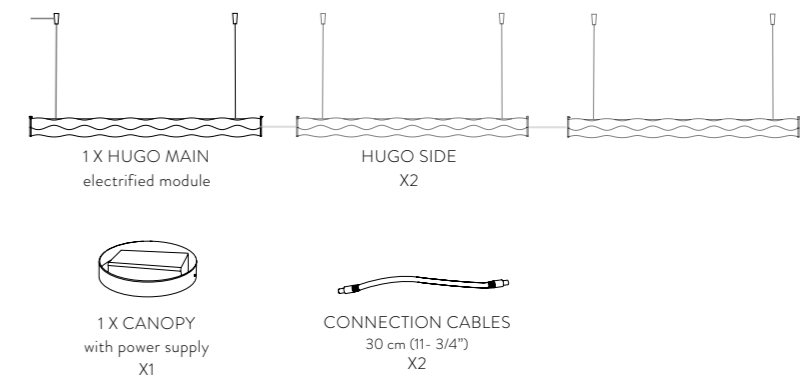

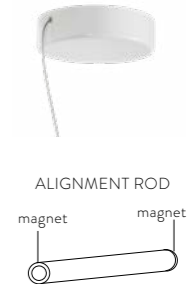
FINISH	PRODUCT CODE	DETAILS	
 <p>PRISMA</p>	<b>2 HUGSSS2PRS01TAR000US</b>	<p>Ø 7,48 x h. 1,97 in</p>  <p>ALIGNMENT ROD magnet magnet</p>	
	<b>3 HUGSSS3PRS01TAR000US</b>		
	ACCESSORIES MUST BE ORDERED WITH THE PRODUCTS		
	6M CABLE KIT		
	MAGNETIC ALIGNMENT ROD (14,5 cm x 1,5 cm)		
	<b>DALI ACC00DALOUNI000B0</b>		
<b>TRIAC ACC00TRI0110000H0</b> ARCH. 2			
<b>CASAMBI ACC00CAI0220000A0</b>			