

TULIP SUSPENSION 14 ROUND

Light Source: 14 X 3,2W Integrated LED 110~220 Vac/24 Vdc - 6.300 Lumen - 3.000 Kelvin

Dimmable: PWM, 0-10

Materials: Lentiflex®, Matte Brushed Brass

Weight: net 13,22 lbs - gross 18,52 lbs

Packaging: 24,41 x 23,23 x h. 2,95 in
31,5 x 15,75 x h. 2,95 in
31,5 x 15,75 x h. 2,95 in

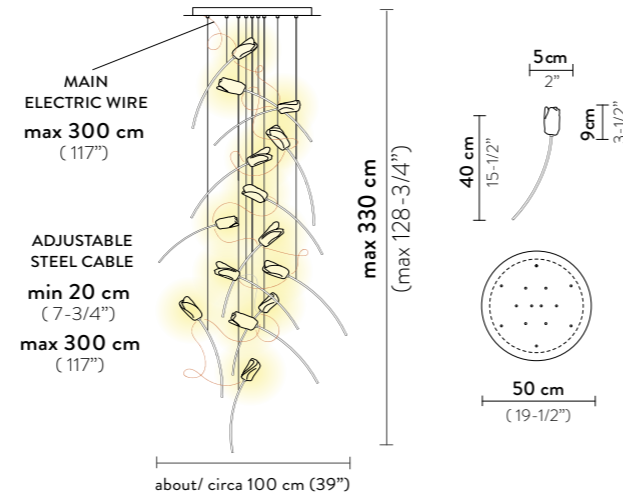

TULIP SUSPENSION 7 ROUND

Light Source: 7 X 3,2W Integrated LED 110~220 Vac/24 Vdc - 3.150 Lumen - 3.000 Kelvin

Dimmable: PWM, 0-10

Materials: Lentiflex®, Matte Brushed Brass

Weight: net 10,58 lbs - gross 14,11 lbs

Packaging: 24,41 x 23,62 x h. 2,95 in
31,5 x 15,75 x h. 2,95 in

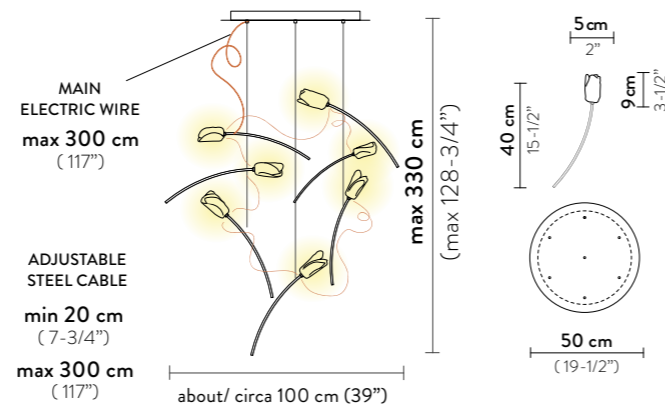

TULIP SUSPENSION 14 LINEAR

Light Source: 14 X 3,2W Integrated LED 110~220 Vac/24 Vdc - 6.300 Lumen - 3.000 Kelvin

Dimmable: PWM, 0-10

Materials: Lentiflex®, Matte Brushed Brass

Weight: net 18,84 lbs - gross 24,59 lbs

Packaging: 48,03 x 13,39 x h. 2,95 in
31,5 x 15,75 x h. 2,95 in
31,5 x 15,75 x h. 2,95 in

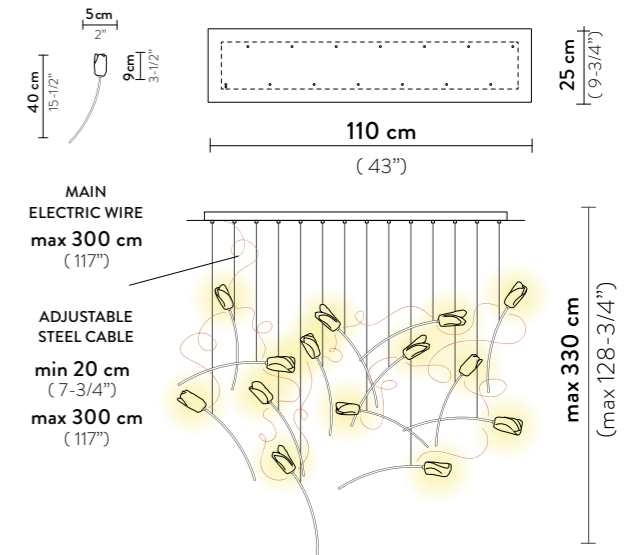

TULIP SUSPENSION 7 LINEAR

Light Source: 7 X 3,2W Integrated LED 110~220 Vac/24 Vdc - 3.150 Lumen - 3.000 Kelvin



Dimmable: PWM, 0-10

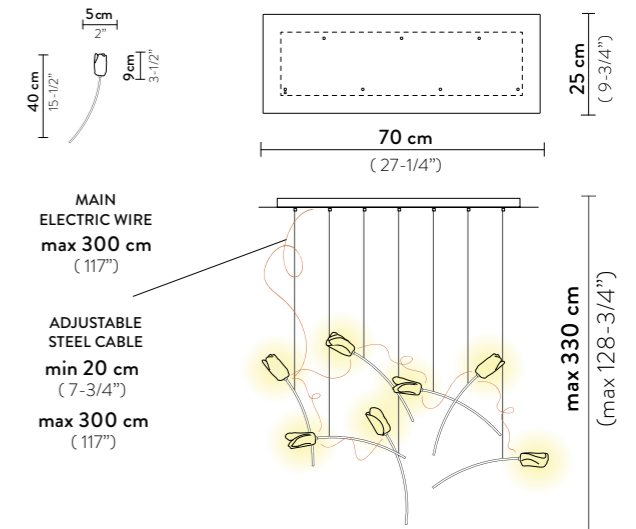

Materials: Lentiflex®, Matte Brushed Brass

Weight: net 11,79 lbs - gross 14,88 lbs

Packaging: 31,5 x 16,14 x h. 2,95 in
31,5 x 15,75 x h. 2,95 in



FINISH	SIZE	PRODUCT CODE	CANOPY DETAILS
 PRISMA/BRASS	14 ROUND	TULSL00PRS03CLDRNCUS	Ø 19,69 x h. 1,77 in  Max distance from one tulip to another (electric copper cable) of 80 cm (31")
	7 ROUND	TULSM00PRS03CLDRNCUS	
	ACCESSORIES MUST BE ORDERED WITH THE PRODUCTS		
	6M CABLE KIT		
	DALI ACC00DAL0UNI000B0		
	TRIAC ACC00TRI0110000W0 14		
TRIAC ACC00TRI0110000T0 7			
CASAMBI ACC00CAI0220000C0			

FINISH	SIZE	PRODUCT CODE	CANOPY DETAILS
 PRISMA/BRASS	14 LINEAR	TULSL00PRS03CLDLNCUS	14 LINEAR: Ø 43,31 - Ø 9,84 x h. 1,77 in  7 LINEAR: Ø 27,56 - Ø 9,84 x h.  Max distance from one tulip to another (electric copper cable) of 80 cm (31")
	7 LINEAR	TULSM00PRS03CLDLNCUS	
	ACCESSORIES MUST BE ORDERED WITH THE PRODUCTS		
	6M CABLE KIT		
	DALI ACC00DAL0UNI000B0		
	TRIAC ACC00TRI0110000W0 14		
TRIAC ACC00TRI0110000T0 7			
CASAMBI ACC00CAI0220000C0			

TULIP SUSPENSION 14 FREE-STANDING

Light Source: 14 X 3,2W Integrated LED 110~220 Vac/24 Vdc - 6.300 Lumen - 3.000 Kelvin
Dimmable: PWM, 0-10
Materials: Lentiflex®, Matte Brushed Brass
Weight: net 8,81 lbs - gross 13,01 lbs
Packaging: 15,75 x 16,93 x h. 2,95 in
 31,5 x 15,75 x h. 2,95 in
 31,5 x 15,75 x h. 2,95 in

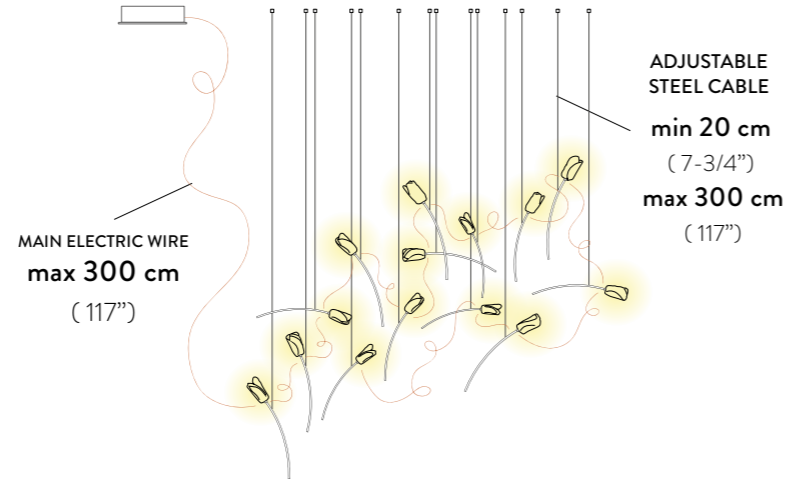

TULIP BATTERY

Light Source: 1 X 1,3W Battery LED - 150 Lumen - 3.000 Kelvin
Dimmable: with integrated dimmer
Materials: Lentiflex®, anodized aluminium
With: at max intensity around 6.5 hours duration, at min intensity around 60 hours duration
Weight: net 1,1 lbs - gross 1,76 lbs
Packaging: 7,48 x 6,69 x h. 18,9 in

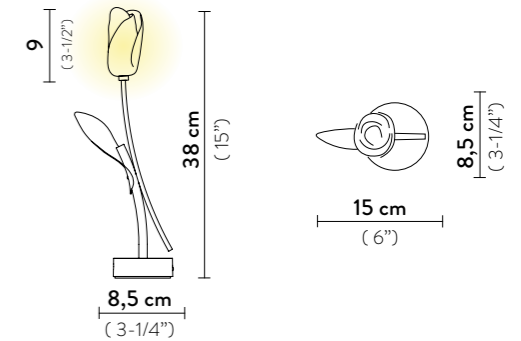

FINISH	PRODUCT CODE	CANOPY DETAILS
<p>PRISMA/BRASS</p>	TULSL00PRS03CLD000US	<p>Ø 11,81 x h. 1,77 in</p> <p>Max distance from one tulip to another (electric copper cable) of 80 cm (31")</p>
	ACCESSORIES MUST BE ORDERED WITH THE PRODUCTS	
	6M CABLE KIT	
	DALI ACC00DAL0UNI000B0	
	TRIAC ACC00TRI0110000W0	
CASAMBI ACC00CAI0220000C0		

FINISH	PRODUCT CODE	DETAILS	
<p>PRISMA/BRASS BLACK PRISMA/BRASS WHITE</p>	TULT000PRS000BDBLBUS BLACK BASE	<p>MATTE BLACK MATTE WHITE</p>	
	TULT000PRS000BDWHBUS WHITE BASE		
	ACCESSORIES MUST BE ORDERED WITH THE PRODUCTS		
	USB MULTICHARGER 20 PORTS ACC00CHAP020_000		